



Digiroad – Description of Data Objects

Release 4/2017 (November 20th 2017)

Table of contents

1	Glossary	1
2	General information.....	2
2.1	Data sources and collection	3
2.2	Data quality.....	3
2.3	Data structure in Digiroad	4
2.3.1	Road link.....	4
2.3.2	Linearly referenced attribute data	4
2.4	Coordinate reference system and height system	5
2.5	Release and delivery formats.....	6
2.5.1	Digiroad R.....	6
2.5.2	Digiroad K.....	6
2.5.3	WMS and WFS interfaces (beta)	7
2.5.4	TN-ITS interface.....	7
3	Digiroad data objects	7
3.1	Road link attribute data	7
3.1.1	Administrative class	7
3.1.2	Functional class	8
3.1.3	Direction of traffic flow.....	10
3.1.4	Road link type	11
3.1.5	Bridge, underpass or tunnel.....	11
3.1.6	Address data.....	12
3.1.7	Road address data.....	12
3.1.8	Geometric accuracy	13
3.1.9	Digitisation direction in relation to the geometry of National Land Survey of Finland	15
3.1.10	Link phase.....	15
3.1.11	Source of the link geometry	15
3.1.12	Other attribute data of the road link.....	16
3.2	Restricted manoeuvre	16
3.3	Point attribute data.....	19
3.3.1	Public transport stop	20
3.3.2	Barrier	23
3.3.3	Traffic light	23
3.3.4	Pedestrian crossing	24
3.3.5	Directional traffic sign.....	24
3.3.6	Railway crossing	25
3.3.7	Forest road turnaround point (pilot).....	25
3.4	Line attribute data	26
3.4.1	Speed limit	27
3.4.2	Maximum allowed ... x 7	27

3.4.3	Lit road	28
3.4.4	Paved road	28
3.4.5	Road affected by thawing	28
3.4.6	Width.....	28
3.4.7	Traffic volume	28
3.4.8	Vehicle specific restriction.....	28
3.4.9	Restriction for the transportation of dangerous goods (VAK) ...	30
3.4.10	Number of lanes (not included in the release 5/2016).....	31
3.4.11	Public transport lane	32
3.4.12	E-road number	32
3.4.13	Exit number.....	32
3.4.14	Winter speed limit	32
3.5	Other features	33
3.5.1	Service	33

APPENDICES

Appendix 1.	Description of data content - field names, data types and code values	1
Appendix 2.	Public transport stop facility data and other attribute data .	1
Appendix 3.	Description of Digiroad R delivery format	1
Appendix 4.	Description of Digiroad K delivery format	1
Appendix 5.	Primary data sources by data objects	1
Appendix 6.	Route type.....	1
Appendix 7.	Time domain character string.....	1

1 Glossary

Digiroad Information System

The Digiroad information system is a national road and street database for which Finnish Transport Agency is responsible and which includes centre line geometry of streets and roads and traffic attribute data.

JHS

Central and local government information management is governed by JHS recommendations (Public Administration Recommendation). JHS refers to a uniform method, specification or guideline issued for the use of central and local government administration.

Centre line geometry

Digiroad centre line geometry is formed by line segments that describe the positions of centre lines of roads, streets, pedestrian and cycle lanes and ferry connections.

Traffic network

Traffic network is an entity consisting of road links connected to each other with nodes. The Digiroad traffic network is topologically consistent, with the exception of certain road links, for examples on islands.

Linear referencing

Linear referencing is a method of indirect spatial referencing in which a position is located by a known point in a linear reference frame (a road link in Digiroad).

Linear reference frame

Linear reference frame is a line geometry from which position in relation to a known point on a line can be determined, for example according to a measure value like in Digiroad.

Linearly referenced object

Linearly referenced feature is a section in the Digiroad road network without a geometry. The feature is located from the road network dynamically by measure values.

Measure value, M value

Measure or M value is attribute data of linear geometry that helps to define the position on a line unambiguously.

Attribute data

Attribute data is an entity of identifiable, timetable and descriptive properties of a feature. Data objects themselves are attribute data for the road network. In addition, there are data object specific attribute data, such as the type of public transport stop and validity direction.

Features of traffic system

A feature of traffic system is an independent part of the system. For example, a public transport stop is a feature of traffic system with its unique attribute data. The position of the

feature may be saved by linear referencing or it may have a position outside the traffic system, indicated by coordinate data.

Point attribute data

The point attribute data refers to attribute data that have a point as the geometric shape of its position. Point attribute data has no M value, with which it could be referenced on the road link geometry. That makes point attribute data separate from the road network. In Digiroad, point attribute data refers to a service.

Point segment

Point segment refers to attribute data whose indirect position is a location in the road link, i.e. a measure. The geometric shape, formed by linear referencing of the attribute data, is a point.

Segment

In Digiroad, a segment refers to road link attribute data that has no geometry of its own. A segment is dynamically located in the road link with M values. There are point and line segments.

Position

In Digiroad, position refers to feature attribute data given by coordinates.

Road link

A linear data object describing the traffic network geometry.

Road link attribute data

Road link attribute data refer to attribute data describing a road link across its entire length. Road link attribute data include data such as functional class, direction of traffic flow and Link-ID.

Data object

Data object refers to traffic network attribute data such as a speed limit or a public transport stop.

Line segment

Line segment refers to attribute data whose indirect position is the distance between two measures on a road link. Line is the geometric shape formed by linear referencing of attribute data.

2 General information

Digiroad is a national road and street information system, which includes centre line geometry of streets and roads, traffic attribute data and the features of the traffic system. Centre line geometry includes vehicle accessible roads, ferry and cable ferry connections for vehicles and separate pedestrian and cycle paths. Traffic attribute data refer to data such as speed limits. Digiroad data can be applied to analyzes and applications related to traffic and navigation.

This document describes the structure and data objects of Digiroad. In this description, data objects have been divided into attribute data of road links, point attribute data and linear attribute data.

Name and identifiers

Digiroad, FI1000018

References

INSPIRE Data Specification on Transport Networks (17.4.2014)

INSPIRE Generic Conceptual Model (18.6.2010)

JHS 177 Paikkatietotuotteiden määrittely (21.10.2010)

Information about definition

Name: Digiroad

Date: 23.5.2016

Author: Finnish Transport Agency (FTA)

Language: Finnish

Metadata

<http://paikkatietohakemisto.fi/geonetwork/srv/fi/metadata.show?uuid=34155a94-b58b-4ad0-87e6-f96d2db0f3ba>

2.1 Data sources and collection

The National Land Survey of Finland, the Finnish Transport Agency, municipalities and (some) other authorities provide source data for Digiroad

Digiroad data covers the entire Finland. Data collection is based on the Law of the data system of road and street network 28.11.2003/991. The primary data sources are specified according to the data objects in Appendix 5. Administrator organizations deliver the updated information to Digiroad in accordance with the agreed procedures. Updates are joined in the Digiroad data system by the Digiroad operator. Digiroad operator gets feedback about the data from different sources, and returns that information to the right administrator organization.

2.2 Data quality

For the present, quality reports or other documents related to the data quality are not published about Digiroad data objects.

Coverage and accuracy of the data

Digiroad data covers the entire Finland. The quarter who utilizes the data should take into account that the maintenance of Digiroad data objects by the municipalities is variable. Therefore, the data quality in different parts of the country varies considerably. The road network data is dependent on the information of the Road Register of the Finnish Transport Agency. This data can also vary on different regions.

Logical integrity

The data is conceptually and topologically sound.

Geometric accuracy

The geometric accuracy of the road links is approximately 5 metres.

Temporal accuracy

The date when geometry has been extracted from NSL Topographic Database is announced in the release notes of each Digiroad data delivery. All the features in Digiroad data include last modified date information. The data is maintained continuously.

Thematic accuracy

Not known.

2.3 Data structure in Digiroad

The centre line geometry of the Digiroad network of roads and streets consists of road links connected to each other by a common end point. Road links are line features representing parts of the road and street network.

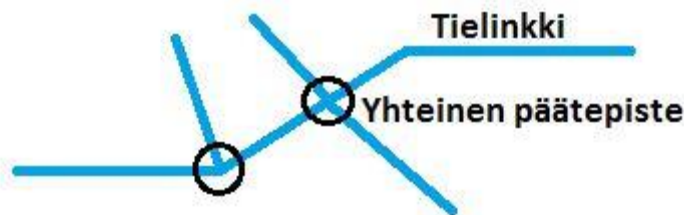

Digiroad network of roads and streets consists of road links.

Tielinkki – Road link

Yhteinen päätepiste – Common end point

Some of the data objects in Digiroad are attribute data of road links. The geometry of a road link has been attached to a measure, i.e. the M value. The M value and the road link are used for locating features linearly by referencing attribute data.

2.3.1 Road link

The Digiroad traffic network consists of road links, which are the smallest units of centre line geometry. Road links usually cover the distance between intersections but can also be shorter. For a more detailed description of road links, please consult the JHS188 recommendation.

2.3.2 Linearly referenced attribute data

Linearly referenced attribute data have been allocated an indirect position using a road link as the linear reference frame. Linearly referenced attribute data do not have their own geometry but refer to a road link and a position on the road link. The M value represents a position on the road link. i.e. the distance from the road link end points. The start M value determines the distance from the start point of the road link to the start of the attribute data,

and the end M value determines the distance from the start point of the road link to the end point of the attribute data. A single M value refers to point reference data. If a feature has a start and end M value, it refers to line attribute data.

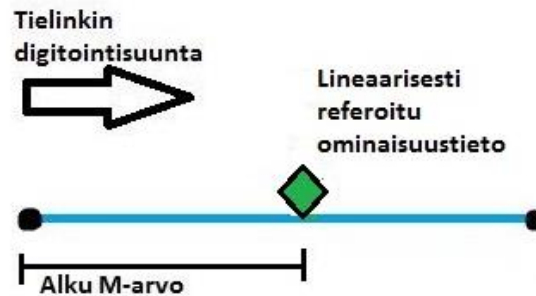

Linearly referenced point attribute data for road links (for example, public transport stop).

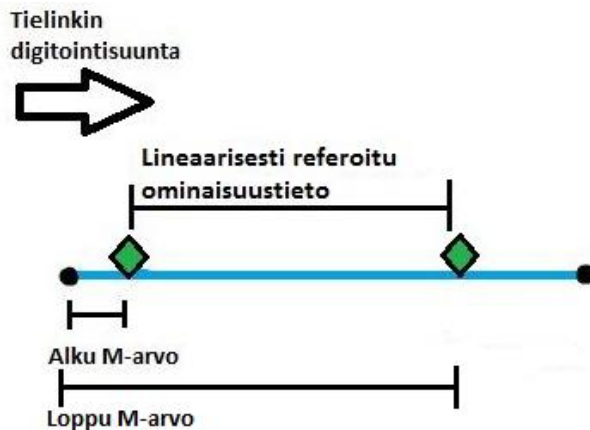

Linearly referenced line attribute data for road links (for example, speed limit).

Tielinkin digitointisuunta – Road link direction of digitization

Lineaarisesti referoitu ominaisuustieto – Linearly referenced attribute data

Alku M-arvo – Start M value

Loppu M-arvo – End M value

2.4 Coordinate reference system and height system

In Digiroad EUREF-FIN coordinate reference system (ETRS-TM35FIN projection based on UTM projection (EPSG: 3067)) and N60 height datum is used. That is a rectangular coordinate system in which a coordinate point has a north coordinate indicated by letter 'P' and an east coordinate indicated by 'I'. The coordinates are given in metres.

As the EUREF-FIN coordinate system deviates from the WGS84 coordinate system by less than one metre, for most purposes the systems can be considered congruent.

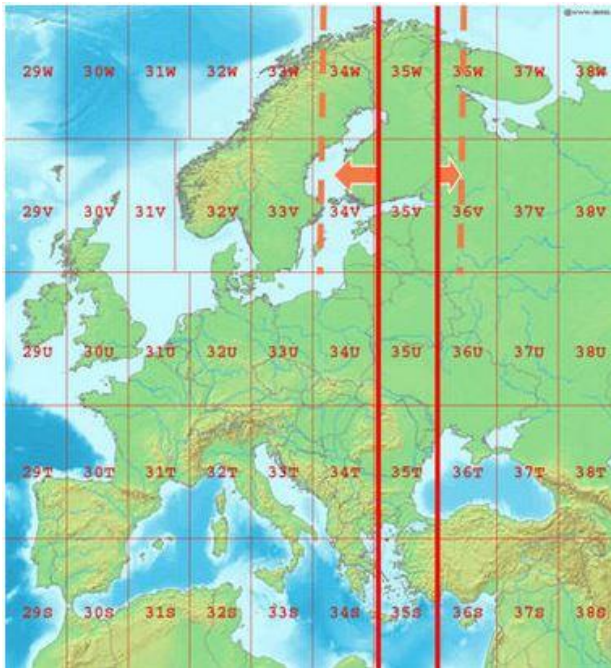

Source: [National Land Survey of Finland](#).

2.5 Release and delivery formats

Digiroad data is published through the Finnish Transport Agency's viewing and downloading service on <http://www.liikennevirasto.fi/web/en>
=> Data and publications => Open data => Services => View and download services.

Different Digiroad data available for exporting in the service are:

- Digiroad R export, files according to the export area
- Digiroad K export, files according to the export area

Files are delivered in ESRI Shapefile format.

2.5.1 Digiroad R

Digiroad R is a delivery format for road links and point and line attribute data. When data is published in Digiroad R, point and line segments are generated geometries, enabling them to be used as individual data. Where necessary, they can be attached to road links by linear referencing. Digiroad R is delivered in ESRI shapefile format.

2.5.2 Digiroad K

Digiroad K is a delivery format in which road links are disconnected into homogenous parts according to their line attribute data. Line attribute data are disconnected in the same way as road links. Point attribute data do not disconnect road links or line attribute data. When material is published in Digiroad K, point and line segments are generated a geometry. In

the Digiroad K delivery format, disconnected line attribute data can be attached to disconnected road links by using their identifier (SEGM_ID). Delivery-specific identifiers are used for disconnected links. This delivery method is suitable for purposes such as MapInfo (version 7 or later). Digiroad K is delivered in ESRI shapefile format.

2.5.3 WMS and WFS interfaces (beta)

In the Finnish Transport Agency's viewing and downloading service, Digiroad is also published by data objects through the WMS and WFS interfaces. Beta versions of the interface services have been released.

2.5.4 TN-ITS interface

Digiroad data changes related to speedlimits and maximum allowed x 7 -attributes are released once a day as a xml file via TN-ITS interface. A link to interface can be found in Digiroad website.

3 Digiroad data objects

This chapter provides information on the data objects used in the new Digiroad system. The definition of the object, attribute data, code values and data type of attribute data, and data coverage are given for each data object. For the fields corresponding to the attribute data in the Digiroad export, please see Appendix 1, Description of data content.

3.1 Road link attribute data

The Digiroad traffic network includes vehicle accessible roads, vehicle tracks, ferry and cable ferry connections for vehicles, and separate pedestrian and cycle paths. The road link geometry is provided by the National Land Survey of Finland. The road link attribute data applies to the entire distance of a road link.

3.1.1 Administrative class

Definition: The administrative class assigns a state, municipality or private owner to a road link. The administrative class does not describe which municipality or road association owns the road. The administrative class is maintained by the National Land Survey of Finland from the beginning of 2016.

Owner type	Code value	Description
State	1	Road is owned by the state (road).
Municipality	2	Road is owned by a municipality (street).
Private	3	The road is privately owned, for example by a road association.
	99	No data

Coverage: Data is included for all road links excluding pedestrian and cycle paths and vehicle tracks.

3.1.2 Functional class

Definition: The functional class describes the importance of a route for traffic. Functional class describes:

- service level of route to the traffic
- intention of the route maintainer to direct traffic to the route.

The functional classes of roads *largely* follow the Finnish Transport Agency's road classification (class I, class II, regional and connecting roads). Functional classes of streets may be determined by municipalities. The basis for the classification is the one used in the land use plan. If a road continues as a street, municipal boundaries and the functional class of the road also affect the classification. The functional classes of private roads are determined in accordance with the importance, width and condition of the road.

Functional class	Code value	Description
Class I main road or regional main street	1	<p>Main roads are the principle roads in the Finnish road network. In the Finnish road numbering system, main roads are numbered from 1 to 39.</p> <p>Regional main street serves mainly long distance or transit traffic and incoming traffic. There may also be traffic within the municipality on a regional main street. In terms of traffic, more important than code value 2 regional main street.</p>
Class II main road or regional main street	2	<p>Class II main roads are part of the Finnish road network complementing the class I network and serving regional traffic. Together with the class I main roads they form the network of Finland's main roads.</p> <p>Regional main street serves mainly long distance or transit traffic and incoming traffic. There may also be traffic within the municipality on a regional main street.</p>

Regional road or local main street	3	<p>Regional roads belong to the Finnish road network serving regional traffic and providing connections to class I and II main roads.</p> <p>Local main street serves mainly traffic within a municipality, e.g. from a suburb to the city centre or the traffic between different surrounding areas. There may also be long-distance, transit or incoming traffic on a local main street.</p>
Connecting road or collector street	4	<p>Connecting roads are roads in the Finnish road network that are not class I or II main roads or regional roads.</p> <p>Collector street collects traffic from a traffic cell to main streets and roads. There should be no through traffic on collector streets in the traffic cells.</p>
Feeder street or class I private road	5	<p>Feeder street connects land use with collector streets and roads. There is a direct connection from a feeder street to a plot of land or a building site.</p> <p>The use of class I private road is commonly allowed and it can be used throughout the year. Typically a class I private road is very important for the traffic in the area and there is also a road association that has been established and it has received funds from the state or municipality.</p>
Class II private road	6	<p>Class II private roads include all other private roads, excluding private and forest roads, which are not in class I private roads and which are accessible by vehicles.</p>
Vehicle track	7	<p>Vehicle tracks are other private or forest roads, which may not be accessible by car but can be used by pedestrians, bicycles or off-road vehicles. Vehicle tracks can connect with the road network without a</p>

		common end point. This is a new class added to the Digiroad data model.
Pedestrian and cycle path	8	Pedestrian and cycle paths are mainly used by pedestrians and bicycles and, in some cases, mopeds.
	0 / null	No data

Coverage: Data applies to all road links.

3.1.3 Direction of traffic flow

Definition: The direction of traffic flow is determined in relation to the direction of digitisation of a road link.

Pedestrian and cycle paths may also be described as one-way if the traffic is only allowed in one direction.

Direction of traffic flow	Code value
Traffic is permitted in both directions	2
Traffic is permitted against the direction of digitisation	3
Traffic is permitted in the direction of digitisation	4

Coverage: Data applies to all road links.

3.1.4 Road link type

Definition: The road link type describes the physical or traffic attribute data of a road link.

Road link type	Code value
Part of a motorway	1
Part of a multiple carriageway, which is not a motorway	2
Part of single carriageway	3
Part of a semi-motorway	4
Part of a roundabout	5
Slip road	6
Rest area	7
Pedestrian or cycle path	8
Part of a pedestrian zone, e.g. a pedestrian street or footpath	9
Part of a service or emergency road	10
Enclosed traffic area	11
Vehicle track, roads accessible by off-road vehicles	12
Service access point on a motorway	13
Ferry/cable ferry	21
	0 / null (no data)

Coverage: Data applies to all road links.

3.1.5 Bridge, underpass or tunnel

Definition: Road link, which is a bridge, underpass or tunnel. The other one of the centre line geometries crossing each other on different levels has a definition underpass while at the same point the other link gets the definition bridge (although in reality the lowest/upper road link is at the ground level).

The bridges that cross each other are classified according to their level in the following way: the first bridge from the ground level gets the value 1, the second one gets the value 2, etc.

Bridge, underpass or tunnel	Code value
Tunnel	-11
Underpass	-1
At the Ground level	0
Bridge, level 1	1
Bridge, level 2	2
Bridge, level 3	3
Bridge, level 4	4

Coverage: Data applies to all road links.

3.1.6 Address data

Definition: A road link, which has a road number, road part number, carriageway information and start and end distance from the beginning of the road part.

Åland has the same road number

The road link address data include street names in Finnish, Swedish and Sami (if present), the first house on the right and left, the last house on the right and left, and the municipality code.

If the road link does not have address numbers, the field value 0 / null (No data) (in the Digiroad releases) is used. If a link is located in the border of two municipalities the municipality code refers to the municipality in which link is mostly located in. The municipality codes consist of one to three digits, no initial zeros are added (eg. Helsinki 91).

3.1.7 Road address data

Definition: Road link including a road number and the number of the part of the road, carriageway and start and end distance for the road link (from the beginning of the road part).

Since Åland and the mainland share the same road numbering space, the road links in Åland have the same road numbers as in the continental Finland.

Coverage: Information applies to all state owned roads.

3.1.8 Geometric accuracy

The accuracy of the horizontal position of the road link is a metric class, for example 3 metres.

Accuracy of the horizontal position	Code value
Not defined	0
0,5 m	500
0,8 m	800
1 m	1000
2 m	2000
3 m	3000
4 m	4000
7 m	5000
7,5 m	7500
8 m	8000
10 m	10000
12,5 m	12500
15 m	15000
20 m	20000
25 m	25000
30 m	30000
40 m	40000
80 m	80000
100 m	100000

If the vertical accuracy information for the road link is interpolated from the height model, the code is either “KM10” (traced from the 10 m resolution height model), or “KM25” (traced from the 25 m resolution height model).

Vertical accuracy	Code value
Not defined	1
KM 2 m	201
0,5 m	500
0,8 m	800
1 m	1000
2 m	2000
3 m	3000
4 m	4000
5 m	5000
7,5 m	7500
8 m	8000
10 m	10000
12,5 m	12500
15 m	15000
20 m	20000
25 m	25000
30 m	30000
40 m	40000
80 m	80000
100 m	100000
KM 10 m	100001

KM 25 m	250001
---------	--------

3.1.9 Digitisation direction in relation to the geometry of National Land Survey of Finland

Definition: With the assistance of this field it can be deduced, if the direction of the digitization has changed in relation to the direction of digitization mentioned in the Topographic database of the National Land Survey of Finland.

Direction of traffic flow	Code value
Direction of digitization remained the same	0
Changed direction of digitization	1

3.1.10 Link phase

Definition: Road link phase specifies, whether the road link is in use, under construction or planned. Link will be defined as “planned” if an investment decision has been made.

Link phase	Code value
Digitisation direction remains the same	0
Under construction	1
Planned	3

3.1.11 Source of the link geometry

Definition: Source of the road link specifies, whether the link geometry derives from the National Land Survey or some other data source. Other sources remain unspecified at least at this stage. If a need for a more detailed information concerning the sources arises in the future, this classification can be specified.

Geometry source	Code value
National Land Survey	1
Other, not specified	2

3.1.12 Other attribute data of the road link

The other attribute data of the road link include the date of the last edition, link ID (N.B. starting from the release 2/2016 LINK_ID field is used to link the road link geometry and the attribute data), MML-ID and the M value of the start and the end point of the link.

The attribute data also includes road classification according to the Topographic database by the National Land Survey (MTK_TIE_LK). The information included in the classification is described more specifically in National Land Survey's website (www.maanmittauslaitos.fi).

3.2 Restricted manoeuvre

Definition: Restricted manoeuvre indicates prohibited or blocked manoeuvres.

Restricted manoeuvre data refers to the relation between road links. Restricted manoeuvre consists at least of the related start and end links (U-turns can consist of up to four links), period of validity, exceptions and additional data. Exceptions indicate the vehicles to which the restriction is not applied.

Manoeuvre data is carriageway specific, not lane specific. Restricted manoeuvre can exist between road links only if turning to another road link is forbidden from each lane.

In Digiroad, no such restricted manoeuvre is maintained that is forbidden by the Road Traffic Act. These include, for example turning to one-way road link against the direction of the traffic flow or turning to pedestrian or cycle path.

Exception to the restricted manoeuvre	Code value
Truck	4
Bus	5
Van	6
Passenger car	7
Taxi	8
Motorcycle	9
Moped	10
Articulated vehicle	13
Tractor or farm vehicle	14
Car with trailer / recreational vehicle	15
Military vehicle	19
Driving in service purposes	21
Driving to a lot	22
Snow mobile	27

Coverage: Information applies to roads, streets and private roads.

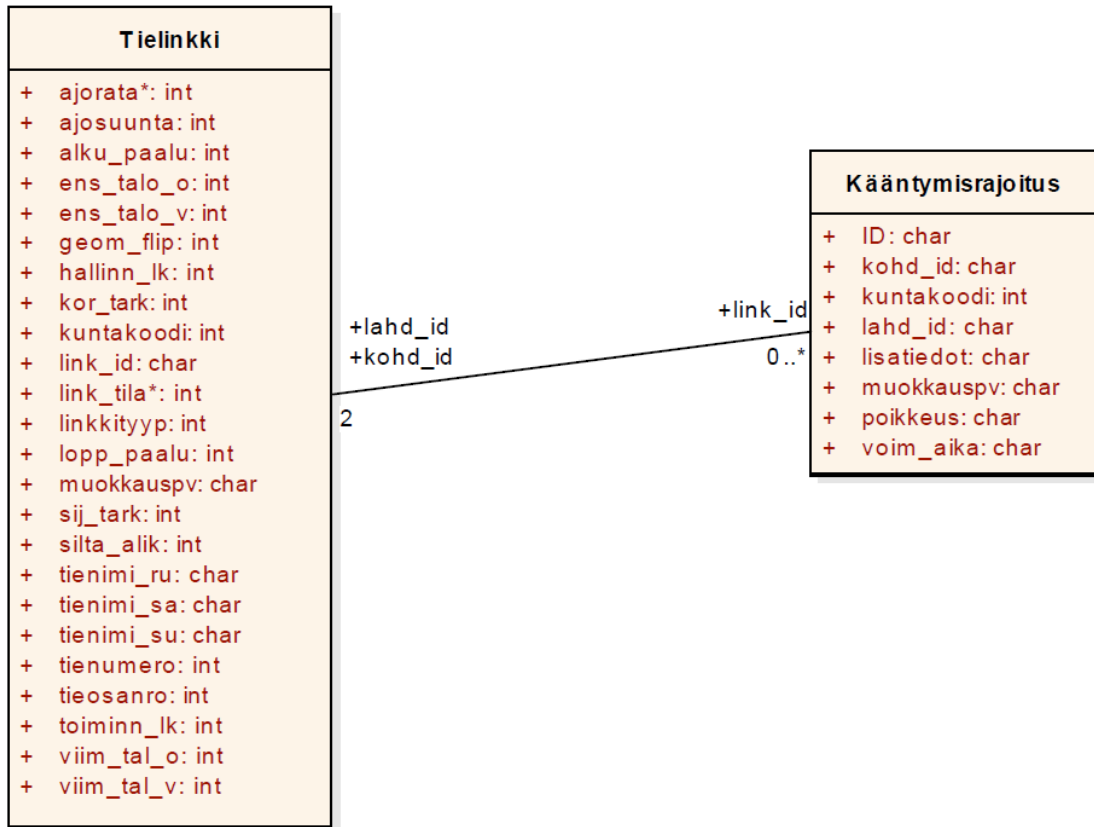

Restricted manoeuvre can be joined to road links according to the source link ID information and the object link ID information.

Tielinkki – Road link

Kääntymisrajoitus – Restricted manoeuvre

lahd_id – Source link ID

kohd_id – Object link ID

3.3 Point attribute data

Point attribute data refer to linear referencing attribute data that have only one M value which is the distance from the start of the link. All point attribute data objects have at least the following data:

Attribute data	Data type	Description
ID*	Numerical	The ID identifying the object
Link ID	Numerical	The link ID of the link where the object is located.
Distance from the start of the link	Numerical	The position of the object on a road link measured from the start.
Last edited	Character string	Time last edited or added to the system.
Municipality code	Code value	Municipality code of the object.

*) For the bus stops, the national ID is used.

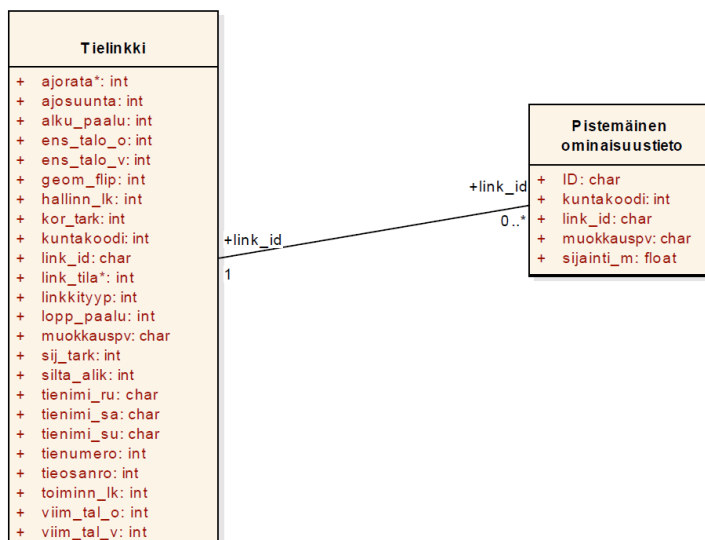

Figure: Point attribute data can be joined to the road links by linear referencing, according to the link ID attribute data and M values.

Tielinkki – Road link

Pistemäinen ominaisuustieto – Point attribute data

3.3.1 Public transport stop

Definition: A stop used by public transport.

The position of the public transport stop either refers to the position in the material provided or a position assigned to the stop in the user interface. In the interface, the position of the stop is generated by linear referencing. In this case, the road link of the stop and the M value determining its position on the road link are known. In addition, the stop is assigned by its coordinates (x, y) in the interface.

The position given by the data provider is indicated in the fields X (east coordinate), Y (north coordinate) and Z (height). These coordinates are assigned in the user interface and do not necessarily match with the linearly referenced positions.

For public transport stop facility data and other attribute data, please see Appendix 2.

Attribute data	Data type	Description	Code values
Coordinate X (east coordinate)	Numerical	X coordinate of the stop in the Digiroad database. Calculated using the road link and M value.	
Coordinate Y (north coordinate)	Numerical	Y coordinate of the stop in the Digiroad database. Calculated using the road link and M value.	
Link ID	Numerical	The Link-ID of the road link where the stop is located*	
M value	Numerical	Stop position on the road link*	
Validity direction	Code value	Stop validity direction in relation to the direction of digitisation of a road link*	2 In the direction of digitisation 3 Against the direction of digitisation
Last edited	Character string	The date the object was last modified.	

National ID	Numerical	Nationally unique identifier for the stop.	
Name in Finnish	Character string	Name of the stop in Finnish.	
Name in Swedish	Character string	Name of the stop in Swedish.	
Data administrator	Code value	Authority administering the data in Digiroad.	1 Municipality 2 Centre for Economic Development, Transport and the Environment (ELY Centre) 3 Helsinki Regional Transport 4 Not known
Administrator identifier	Character string	The unique identifier assigned to the stop by the administrator in their own system.	
Livi identifier	Character string	The stop Livi identifier that corresponds to the identifier in the Road Register. Only applies to stops on the roads.	
Traveller identifier	Character string	The stop identifier physically displayed at the public transport stop.	
Ground coordinate X (east coordinate)	Character string	The calculated X coordinate of the stop's location. Ground coordinates are provided by the data administrator and may not correspond to those given in the application.	

Ground coordinate Y (north coordinate)	Character string	The calculated Y coordinate of the stop's location. Ground coordinates are provided by the data administrator and may not correspond to those given in the application.	
Ground coordinate Z	Character string	The calculated Z coordinate of the stop's location. Ground coordinates are provided by the data administrator and may not correspond to those given in the application.	
Direction of travel	Character string	Free description of the direction of the stop.	
Traffic bearing	Numerical	Degree between 0 and 360. Describes the stop validity direction.	
Valid from date	Time stamp	Date when the stop is first used.	
Valid to date	Time stamp	Date when the stop is used for the last time.	
Stop type	Code value	The stop type indicates the type of traffic served by the stop. A stop may be assigned more than one type.	<ul style="list-style-type: none"> 1 Tram 2 Local transport 3 Long-distance transport 4 Express bus 5 Virtual stop

			99 No data
Disconnected from geometry**	Code value	The geometry of the road link where the stop is located has changed considerably, disconnecting the stop from the geometry.	1 Connected to geometry 2 Disconnected from the geometry

*) If the stop is disconnected from geometry, its Link-ID, M value and validity direction are null.

***) The expired stops anymore are not updated to the link geometry if the geometry is changed.

Coverage: A public transport stop can be located on any road link with the exception of pedestrian and cycle paths, ferries and cable ferries.

3.3.2 Barrier

Definition: Barriers are blocked passages or traffic barrier gates which can be opened. Blocked passage refers to a physical barrier on the road and street network that prevents passing through. For example, the connection of the streets may be blocked with stones, ditch or a traffic barrier gate which cannot be opened.

A traffic barrier gate which can be opened is a point in a central line geometry which is locked, but can be opened.

Barrier type	Code value
Blocked passage	1
Traffic barrier gate which can be opened	2

Coverage: Information applies to streets and private roads.

3.3.3 Traffic light

Definition: Intersection traffic light control is as point segment at the distance of 5 meters from the intersection. It applies on all the links that have direction of travel towards the intersection.

A traffic light that is between intersections is described as a point e.g. beside a pedestrian crossing guided by traffic lights in the case that no intersecting geometry exists.

Coverage: Information applies to roads and streets.

3.3.4 Pedestrian crossing

Definition: A pedestrian crossing marked with a traffic sign and road markings.

Coverage: Information applies to streets.

3.3.5 Directional traffic sign

Definition: Directional traffic sign and its information are the signposts which are situated on or directing to motorways or semi-motorways. Typically directional sign is located at a junction or just before it. There may be several directions (pieces of information on a directional sign) on a directional traffic sign.



Image shows four directions, i.e. four pieces of information, on a directional traffic sign (in a directional traffic sign segment).

Directional traffic sign information contains the following data, separated by a semicolon:

PLACE NAMES;COLOUR;LOCATION

Within the fields, the information is separated by a colon, for example:

"HELSINKI:HELSINGFORS;1;500"

More detailed description of the parts of the character string:

Place names: Names of places written as in the directional traffic sign (all CAPITAL letters).

Background colour:

- 1 no data
- 2 green (motorway or semi-motorway)
- 3 blue (road)
- 4 white (local, e.g. a town district))

Location: Distance of the directional traffic sign from the junction in metres.

Attribute data	Data type	Description	Code values
Validity direction	Code value	Direction of travel in relation to the direction of the digitation on link.	2 In the direction of the digitisation 3 Against the direction of the digitisation
Bearing	Numerical	Degree	
Text	Character string	List of content	

Coverage: Information applies to streets, roads (1-299), and some private roads. Information is not particularly comprehensive and its quality may vary according to the area.

3.3.6 Railway crossing

Definition: Railway crossing include:

- a name
- type of safety device

Type of safety device	Code value
Railway not in use	1
No safety device	2
Only light and/or sound signal	3
Half barrier and possible light and/or sound signal	4
Full barrier and possible light and/or sound signal	5

Coverage: Information applies to roads, streets and some private roads.

3.3.7 Forest road turnaround point (pilot)

Definition: A forest road turnaround point which is meant for a timber truck (a truck with timber cargo).

Coverage: Forest road turnaround point data is pilot data produced from Forest Centre data.

3.4 Line attribute data

Line attribute data refers to linear referencing attribute data in which the start and end M values are not the same. All line attribute data objects have at least the following data:

Attribute data	Data type	Description
ID	Numerical	The ID identifying the object
Link ID	Numerical	The Link ID of the link where the object is located.
Start M value	Numerical	The distance of the start point from the start of the link.
End M value	Numerical	The distance of the end point from the start of the link.
Last edited	Character string	The date the object was last modified.
Municipality code	Code value	Municipality code of the object.

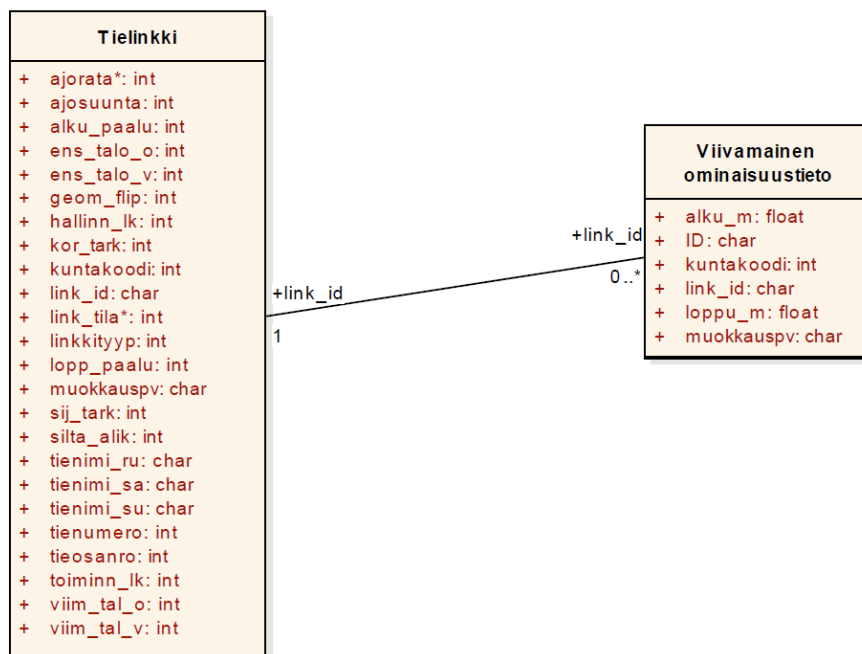

Image: Line attribute data can be joined to the road links by linear referencing, according to the link ID attribute data and the M values.

Tielinkki – Road link

Viivamainen ominaisuustieto – Line attribute data

3.4.1 Speed limit

Definition: The maximum vehicle speed assigned to a route.

Attribute data	Data type	Description	Code values
Validity direction	Code value	Validity direction in relation to the direction of digitisation of a road link.	1 Both directions 2 In the direction of digitisation 3 Against the direction of digitisation

Values: Arvo (value) field indicates the speed limit value (km/h). Speed limit 90 km/h is only used in Åland.

Coverage: Speed limit applies to all road links excluding pedestrian and cycle paths and vehicle tracks. If the administrator has not updated the road link speed limit, an empty speed limit with null value is generated for the link. The null speed limit does not have an ID.

3.4.2 Maximum allowed ... x 7

Maximum allowed restrictions are:

- Maximum weight allowed for a vehicle
- Maximum weight allowed for an articulated vehicle
- Maximum weight per axle allowed for a vehicle
- Maximum weight per tandem-axle allowed for a vehicle
- Maximum height allowed for a vehicle
- Maximum length allowed for a vehicle or articulated vehicle
- Maximum width allowed for a vehicle

Definition: The 'maximum allowed...' attribute data are line attribute data that cover all the area, where the restriction is valid. The weight restrictions are indicated with an accuracy of 100 kilograms and the height, length and width restrictions as centimetres. For roads, height restrictions below 440 cm are indicated. The unit of weight restrictions is kg and the unit of height, length and width restrictions is cm.

Values: Arvo (value) field indicates the value of the restriction (kg or cm).

Coverage: Information applies to roads, streets and some private roads. The information is to be saved for all the area, where the restriction is valid.

3.4.3 Lit road

Definition: The road has lighting. Lit road is line attribute data which may apply to the whole link or only to a part of it.

Coverage: Information applies mainly to roads and streets.

3.4.4 Paved road

Definition: All pavement types are classified as pavements. There is no pavement segment on the part of road network covered with gravel. Nearly always the pavement information covers the whole link. The data source for all road links is the Topographic database of The National Land Survey of Finland.

Coverage: Information applies to all route types.

3.4.5 Road affected by thawing

Definition: Road affected by thawing is the part of the traffic network that tends to suffer from thawings.

Coverage: Information applies mainly to main roads.

3.4.6 Width

Definition: Road width is the width of the part of the carriageway meant for vehicle traffic. On paved roads the carriageway is often separated from the shoulders with a white border line. If a border line doesn't exist, the width equals the width of the paving. On gravel roads the width equals the width of the whole road, since gravel roads don't have shoulders.

Values: Arvo (value) field indicates the value of the width (cm).

Coverage: Information applies to roads, streets and private roads.

3.4.7 Traffic volume

Definition: Traffic volume is the average number of vehicles passing per day. If the road that consists of one carriageway is split into two carriageways, both carriageways get the same traffic volume value that existed for the road before the splitting.

Values: Arvo (value) field indicates the traffic volume (vehicles per day).

Coverage: Information applies to roads and partially to the road network. From publication 3/2017 the information is produced directly from FTA Road register. The inventory information is updated once a year and it is based on measurements made during the previous fall.

3.4.8 Vehicle specific restriction

Definition: A part of the road network where driving with a certain vehicle type(s) is prohibited by traffic signs. Validity period can be given by a vehicle specific restriction. The vehicles that are not covered by the restriction can be added as exceptions to the vehicle, motor vehicle and passage through restrictions.

In Digiroad, the vehicle specific restrictions which the Road Traffic Act imposes or which are indicated by the selection of the road link type are not maintained on motorways and other corresponding road types (including semi-motorway, pedestrian and cycle path).

If one position includes several prohibited vehicle types, objects that overlap by geometry are formed to the R and K releases of Digiroad. These objects have the same restriction ID, position information and last edited time data.

Attribute data	Data type	Description	Code values
Validity direction	Code value	Validity direction in relation to the direction of digitisation of a road link.	1 Both directions 2 In the direction of digitisation 3 Against the direction of digitisation
Type of prohibited vehicle	Code value	Type of prohibited vehicle	2 Motor vehicle 3 Vehicle 4 Truck 5 Bus 6 Delivery vehicle 7 Passenger car 8 Taxi 9 Motorcycle 10 Moped 11 Cycle 12 Pedestrian 13 Articulated vehicle

			14 Tractor or farm vehicle 15 Car with trailer / recreational vehicle 19 Military vehicle 21 Driving in service purposes 22 Driving to a lot 23 Passage through 26 Horse riding 27 Snow mobile
Validity period	Character string	Validity period of the restriction, time domain	
Exceptions	Code value	Vehicle types not covered by the restriction. Exceptions can apply to restrictions of vehicle, motor vehicle and passage through.	Same code values as in the type of prohibited vehicle.

Coverage: Information applies mainly to roads and streets.

3.4.9 Restriction for the transportation of dangerous goods (VAK)

Definition: A part of the road network where the transportation of dangerous goods (VAK) is prohibited.

The value of VAK restriction can be A-VAK or B-VAK which is shown in a plate of the restriction sign.

If the restriction includes both A-VAK and B-VAK, they will be formed as geometrically overlapping objects to the R and K releases of Digiroad. A-VAK and B-VAK are never valid simultaneously, so the overlapping objects have always a period of validity for the restriction. These objects have the same restriction ID, position information and last edited time data.

Attribute data	Data type	Description
Validity direction	Code value	Validity direction in relation to the direction of digitisation of a road link.

		1 Both directions 2 In the direction of digitisation 3 Against the direction of digitisation
Type of prohibited vehicle	Code value	24 A-VAK 25 B-VAK
Validity period	Character string	Validity period of the restriction, time domain

Coverage: Information applies to roads and streets.

3.4.10 Number of lanes (not included in the release 5/2016)

Definition: Information on the number of lanes is given according to the direction when there is more than one lane in a particular direction on one carriageway roads, and more than two lanes on two carriageway roads. Diverging lanes on the junctions are not included.

In the following cases, there is no information on the number of lanes in Digiroad:

- one-way road with one carriageway: 1 lane (one lane in the direction of the traffic flow)
- two-way road with one carriageway: 1+1 lanes (one lane in the direction of the traffic flow)
- two-way road with two carriageways: 2+2 lanes (two lanes in the direction of the traffic flow)

Example 1: In a one carriageway road at the point where there is a passing/fast lane in the direction of the digitisation, the validity direction is 2 and the number of lanes 2.

Example 2: In a one carriageway road at the point where there are passing/fast lanes to both directions, the validity direction is 1 and the number of lanes 2.

Attribute data	Data type	Description
Validity direction	Code value	Validity direction in relation to the direction of digitisation of a road link. 1 Both directions 2 In the direction of the digitisation 3 Against the direction of digitisation
Number of lanes	Numerical	Number of lanes according to the direction (>1)

Coverage: Information applies to roads and streets.

3.4.11 Public transport lane

Definition: A road with a public transport lane.

Attribute data	Data type	Description
Validity direction	Code value	Validity direction in relation to the direction of digitisation of a road link. 1 Both directions 2 In the direction of the digitisation 3 Against the direction of digitisation

Coverage: Information applies to roads and streets.

3.4.12 E-road number

Definition: E-road number are of the form E+<number>. One road can have many E-road numbers.

If a road has two or more E-road numbers, they are listed in R and K releases of Digiroad and separated from each other by a comma.

Coverage: Information applies to roads and in few cities also to streets.

3.4.13 Exit number

Definition: Exit numbers are numbers given to ramps on motorways or semi-motorways. Exit numbers can consist of both a number and a letter, for example exit numbers 9A and 9B in Vantaankoski.

If one road has two or more exit numbers, they are listed in R and K releases of Digiroad and separated from each other by a comma.

Coverage: Information applies to the motorway and semi-motorway ramps (on the roads).

3.4.14 Winter speed limit

Definition: Speed limit during winter data is based on decisions made by local road authorities (ELY) in autumn 2016. Speed limits during winter is no longer applied on the road segments (in the intersections) where regular speed limit is lower than speed limit during winter.

Values: Arvo (value) field indicates the value of the winter speed limit (km/h).

Coverage: Information applies to roads.

3.5 Other features

3.5.1 Service

Definition: Service means the kind of service that helps and supports the users of traffic network, e.g. a parking building or bus station. Service has a point geometry (service point) which is located at the point where the service exist (in the middle/centre point of a building or property), not on a road link. One service point may have many services.

If one service point has many services, objects that overlap the geometry are formed to the shapefiles of the R and K releases of Digiroad. These overlapping objects have the same service point ID, position information and last edited time.

Attribute data	Data type	Description
Service point ID	Numerical	The ID identifying the service point
Service ID	Numerical	The ID identifying the service
Palvelutyyppi	Code value	The type of the service
Specifier of the rest area	Code value	The type of the rest area on rest areas or lay-bys, parking areas and bus and truck parking areas
Type of railway station	Code value	
Name of service	Character string	
Number of parking spaces	Numerical	Number of parking spaces on parking areas and houses
Additional information of the service	Character string	

Type of service	Code value	Description
Customs	4	
Frontier crossing	5	
Rest area (or lay-by)	6	Rest area, petrol station, kiosk, cafeteria, restaurant or accommodation services.
Airport	8	An airport which accommodates either cargo or passenger traffic of a commercial or private nature.
Ferry terminal	9	The access point or check-in area for a ferry company.
Taxi stand	10	
Railway station	11	
Parking lot	12	Parking lot which has at least 40–50 public parking spaces. There may be a charge for parking but there may not be other restrictions (e.g. parking only allowed for customers of a particular store). In addition, parking lot object can also include more accurate information about facilities.
Car shipping terminal	13	A location where cars may be loaded onto trains or ferries.
Coach and lorry parking (area / lot)	14	
Parking house/building	15	Parking house/building which has at least 40–50 public parking spaces. There may be a charge for parking but there may not be other restrictions (e.g. parking only allowed for customers of a particular store).
Bus station	16	

Type of rest area	Code value	Description
Rest area, comprehensive facilities	1	Comprehensive facilities include other facilities and services in addition to the basic ones
Rest area, basic facilities	2	Basic facilities include the following facilities or services: - parking area - waste container - toilets - table and bench
Private service area	3	Privately run service area has e.g. a petrol station, kiosk, cafeteria, restaurant or accommodation services.
No data	4	

Type of railway station	Code value
Important railway station	1
Less important railway station	2
Underground/metro station	3

Coverage: The coverage of data varies according to the service.

Appendices

Appendix 1. Description of data content - field names, data types and code values

Appendix 2. Public transport stop facility data and other attribute data

Appendix 3. Description of Digiroad R delivery format

Appendix 4. Description of Digiroad K delivery format

Appendix 5. Primary data sources by data objects

Appendix 6. Route type

Appendix 7. Time Domain character string

Appendix 1. Description of data content - field names, data types and code values

Road link

Line

Description	Field (shape)/ Element (WFS)	Data type (shape)	Additional information
Link breakpoints	shape/ points	geometry (polylineZm)	X and Y coordinates: ETRS-TM35FIN Z coordinate: N60 M value: metre (X ,Y level)
Link ID	LINK_ID	text, 20	
ID (by the National Land Survey)*	LINK_MML_ID	text, 20	
Administrative class	HALLINN_LK	integer	code value
Functional class	TOIMINN_LK	integer	code value
Direction of traffic flow	AJOSUUNTA	integer	code value
Link type	LINKKITYYP	integer	code value
Bridge, underpass or tunnel	SILTA_ALIK	integer	code value
Link phase	LINK_TILA	integer	code value (to be published later)
Name of road or street in Finnish	TIENIMI_SU	text, 200	
Name of road or street in Swedish	TIENIMI_RU	text, 200	

Name of road or street in Sami	TIENIMI_SA	text, 200	
Address first house on the left	ENS_TALO_V	integer	
Address first house on the right	ENS_TALO_O	integer	
Address last house on the left	VIIM_TAL_V	integer	
Address last house on the right	VIIM_TAL_O	integer	
Municipality code	KUNTAKOODI	integer	
Road number	TIENUMERO	integer	
Number of the part of a road	TIEOSANRO	integer	
Carriageway	AJORATA	integer	code value
Start measure from the beginning of the road part	AET	integer	
End measure from the beginning of road part	LET	integer	
Horizontal accuracy	SIJ_TARK	integer	code value
Vertical accuracy	KOR_TARK	integer	code value
Digitisation direction in relation to the geometry of National Land Survey of Finland	GEOM_FLIP	integer	code value
Start M value	ALKU_PAALU	double	

End M value	LOPP_PAALU	double	
Last edited	MUOKKAUSPV	text, 20	time stamp "12.06.2014 13:29:17"
Source geometry	GEOM_LAHDE	integer	code value
Road classification according to the Topographic database (National Land Survey)	MTK_TIE_LK	integer	code value, explanations can be found in the description by the National Land Survey

* If the link does not have a MML-ID, this means that its' source is some other than the National Land Survey.

Name	Code value	Description
Administrative class	1	Road owned by the state
	2	Road owned by a municipality
	3	Road owned privately, e.g. by a road association
	99	No data
Functional class	1	Class I main road or regional main street
	2	Class II main road or regional main street
	3	Regional road or local main street
	4	Connecting road or collector street
	5	Feeder street or class I private road

Digiroad

	6	Class II private road
	7	Vehicle track
	8	Pedestrian and cycle path
	0 / null	No data
Direction of traffic flow	2	Traffic is permitted in both directions
	3	Traffic is permitted against the direction of digitisation
	4	Traffic is permitted in the direction of digitisation
Link type	1	Part of a motorway
	2	Part of a multiple carriageway, which is not a motorway
	3	Part of single carriageway
	4	Part of a semi-motorway
	5	Part of a roundabout
	6	Slip road
	7	Rest area
	8	Pedestrian or cycle path
	9	Part of a pedestrian zone, e.g. a pedestrian street or footpath

Digiroad

	10	Part of a service or emergency road
	11	Enclosed traffic area
	12	Vehicle track, roads accessible by off-road vehicles
	13	Service access point on a motorway
	21	Ferry/cable ferry
	0 / null	No data
Bridge, underpass or tunnel	-11	Tunnel
	-1	Underpass
	0	At ground level
	1	Bridge, level 1
	2	Bridge, level 2
	3	Bridge, level 3
	4	Bridge, level 4
Link phase	1	In use
	2	Under construction
	3	Planned
	9	Removed

Digiroad

Carriageway	1	First carriageway on the right in the direction of the road number
	2	Second carriageway on the right in the direction of the road number
	9	Single carriageway road
Accuracy for the geometries	0	Not defined
	500	0,5 m
	800	0,8 m
	1000	1 m
	2000	2 m
	3000	3 m
	4000	4 m
	5000	7 m
	7500	7,5 m
	8000	8 m
	10000	10 m
	12500	12,5 m
	15000	15 m
	20000	20 m

Digiroad

	25000	25 m
	30000	30 m
	40000	40 m
	80000	80 m
	100000	100 m
Vertical accuracy	1	Not defined
	201	KM (EM) (traced from the 2 m resolution model)
	500	0,5 m
	800	0,8 m
	1000	1 m
	2000	2 m
	3000	3 m
	4000	4 m
	5000	5 m
	7500	7,5 m
	8000	8 m
	10000	10 m

Digiroad

	12500	12,5 m
	15000	15 m
	20000	20 m
	25000	25 m
	30000	30 m
	40000	40 m
	80000	80 m
	100000	100 m
	100001	KM (EM) 10 m (traced from the 10 m resolution model)
	250001	KM 25 m (traced from the 25 m resolution model)
Digitisation direction in relation with the geometry of National Land Survey of Finland	0	Direction of digitization remained the same
	1	Changed direction of digitisation
Source geometry	1	National Land Survey
	2	other, not specified

Restricted manoeuvre

Relationship between the links

Restricted manoeuvre information is complementary data for road links. Its utilization requires that the road link material/data is in use. For visualization, the geometry for the restricted manoeuvre has been formed in the release from the geometry of the source and object links.

Description	Field (shape)/ Element (WFS)	Data type (shape)	Additional information
ID	ID	text, 20	
Position	shape/ points	geometry (polylineZ)	ETRS-TM35FIN, formed from the source and object link geometry
Source link ID	LAHD_ID	text, 20	
Object link ID	KOHD_ID	text, 20	
Vehicles not covered by restricted manoeuvre	POIKKEUS	text, 40	comma-separated list of vehicle types
Validity period	VOIM_AIKA	text, 200	time domain

Additional information	LISATIEDOT	text, 200	
Last edited	MUOKKAUSPV	text, 50	time stamp "12.6.2014 13:29:17"
Municipality code	KUNTAKOODI	integer	

Name	Code value	Description
Vehicle type	4	Truck
	5	Bus
	6	Van
	7	Passenger car
	8	Taxi
	9	Motorcycle
	10	Moped
	13	Articulated vehicle
	14	Tractor or farm vehicle
	15	Car with trailer/ recreational vehicle

Digiroad

	19	Military vehicle
	21	Driving in service purposes
	22	Driving to a lot
	27	Snow mobile



Public transport stop

Point

Description	Field (shape)/ Element (WFS)	Data type (shape)	Additional information
National ID	VALTAK_ID	integer	
Position	shape/ point	geometry (pointZ)	ETRS-TM35FIN
Coordinate X	KOORD_X	double	ETRS-TM35FIN
Coordinate Y	KOORD_Y	double	ETRS-TM35FIN
Link ID	LINK_ID	text, 20	
Sijainti linkillä	SIJAINTI_M	double	M value: metre (x, y level)
Validity direction	VAIK_SUUNT	integer	code value
Name in Finnish	NIMI_SU	text, 200	
Name in Swedish	NIMI_RU	text, 200	
Data administrator	YLLAPITAJA	integer	code value
Administrator identifier	YLLAP_TUNN	text, 50	
Livi identifier	LIVI_TUNN	text, 50	

Traveller identifier	MATK_TUNN	text, 50	
Ground coordinate X	MAAST_X	text, 50	
Ground coordinate Y	MAAST_Y	text, 50	
Ground coordinate Z	MAAST_Z	text, 50	
Direction of travel	LIIK_SUUNTA	text, 200	
Traffic bearing	L_SUUNTIMA	integer	degree 0-360
Valid from date	ENS_VO_PV	text, 50	time stamp "12.06.2014"
Valid to date	VIIM_VO_PV	text, 50	time stamp "12.06.2014"
Stop type	PYS_TYYPPI	text, 20	comma-separated list of types, no square brackets
Timetable	AIKATAULU	integer	code value
Shelter	KATOS	integer	code value
Bench	PENKKI	integer	code value
Advertising shelter	MAINOSKAT	integer	code value
Cycle rack	PYORATELIN	integer	code value
Electronic timetable board	S_AIKATAUL	integer	code value
Lighting	VALAISTUS	integer	code value

Accessibility to persons with reduced mobility	ESTETTOMYY	text, 200	
Possibility to escort by car	SAATTOMAHD	integer	code value
Number of park-and-ride places	LIIT_LKM	text, 200	
Additional information on park-and-ride facilities	LIIT_LISAT	text, 200	
Stop owner	PYS_OMIST	text, 200	
Feedback address	PALAUTE_OS	text, 200	
Additional information	LISATIEDOT	text, 200	
Disconnected from geometry	IRTI_GEOM	integer	code value
Last edited	MUOKKAUSPV	text, 50	time stamp "12.06.2014 13:29:17"
Municipality code	KUNTAKOODI	integer	

Name	Code value	Description
Data administrator	1	Municipality
	2	Centre for Economic Development, Transport and the Environment

Digiroad

	3	Helsinki Regional Transport
	99	Unknown
Validity direction	2	In the direction of digitisation
	3	Against the direction of digitisation
Stop type	1	Tram
	2	Local transport
	3	Long-distance transport
	4	Express
	5	Virtual stop
	99	No data
Disconnected from geometry	1	Connected to geometry
	2	Disconnected from geometry
Timetable	1	No
	2	Yes
	99	No data

Digiroad

Shelter	1	No
	2	Yes
	99	No data
Advertising shelter	1	No
	2	Yes
	99	No data
Bench	1	No
	2	Yes
	99	No data
Cycle rack	1	No
	2	Yes
	99	No data
Electronic timetable board	1	No
	2	Yes
	99	No data
Lighting	1	No
	2	Yes
	99	No data
Possibility to escort by car	1	No
	2	Yes
	99	No data

Barrier Point

Description	Field (shape)/ Element (WFS)	Data type (shape)	Additional information
ID	ID	text, 20	
Position	shape/ point	geometry (pointZ)	ETRS-TM35FIN
Link ID	LINK_ID	text, 20	
Distance from the start of the link	SIJAINTI_M	double	
Barrier type	EST_TYYPPI	integer	code value
Last edited	MUOKKAUSPV	text, 50	time stamp "12.06.2014 13:29:17"
Municipality code	KUNTAKOODI	integer	

Name	Code value	Description
Barrier type	1	Blocked passage
	2	Traffic barrier gate which can be opened

Traffic light

Point

Description	Field (shape)/ Element (WFS)	Data type (shape)	Additional information
ID	ID	text, 20	
Position	shape/ point	geometry (pointZ)	ETRS-TM35FIN
Link ID	LINK_ID	text, 20	
Distance from the start of the link	SIJAINTI_M	double	
Last edited	MUOKKAUSPV	text, 50	time stamp "12.06.2014 13:29:17"
Municipality code	KUNTAKOODI	integer	

Pedestrian crossing

Point

Description	Field (shape)/ Element (WFS)	Data type (shape)	Additional information
ID	ID	text, 20	
Position	shape/ point	geometry (pointZ)	ETRS-TM35FIN
Link ID	LINK_ID	text, 20	
Distance from the start of the link	SIJAINTI_M	double	
Last edited	MUOKKAUSPV	text, 50	time stamp "12.06.2014 13:29:17"
Municipality code	KUNTAKOODI	integer	

Directional traffic sign

Point

Description	Field (shape)/ Element (WFS)	Data type (shape)	Additional information
ID	ID	text, 20	
Sijainti	shape/ point	geometry (pointZ)	ETRS-TM35FIN
Link ID	LINK_ID	text, 20	
Distance from the start of the link	SIJAINTI_M	double	
Validity direction	VAIK_SUUNT	integer	code value
Bearing	SUUNTIMA	integer	degree
Text	TEKSTI	text, 200	comma-separated list of texts
Last edited	MUOKKAUSPV	text, 50	time stamp "12.06.2014 13:29:17"
Municipality code	KUNTAKOODI	integer	

Name	Code value	Selite
Validity direction	2	In the direction of digitisation
	3	Against the direction of digitisation

Railway crossing

Point

Description	Field (shape)/ Element (WFS)	Data (shape)	Additional information
ID	ID	text, 20	
Position	shape/ point	geometry (pointZ)	ETRS-TM35FIN
Link ID	LINK_ID	text, 20	
Distance from the start of the link	SIJAINTI_M	double	
Name of the railway crossing	NIMI	text, 200	
Type of safety device	TURVA_VAR	Integer	code value
Last edited	MUOKKAUSPV	text, 50	time stamp "12.06.2014 13:29:17"
Municipality code	KUNTAKOODI	integer	

Name	Code value	Description
Type of safety device	1	Railway not in use
	2	No safety device
	3	Only light and/or sound signal

	4	Half barrier and possible light and/or sound signal
	5	Full barrier and possible light and/or sound signal

Forest road turnaround point (pilot)

Point

Description	Field (shape)/ Element (WFS)	Data type (shape)	Additional information
ID	ID	text, 20	formed from the administrator and administrator's ID for example 1_5877
Position	shape/ point	geometry (pointZ)	ETRS-TM35FIN
Link ID	LINK_ID	text, 20	
Distance from the start of the link	SIJAINTI_M	double	
Type of turnaround point	KAANT_TYYP	integer	code value
Additional information of the turnaround point	LISATIEDOT	text, 200	
Administrator of the turnaround point	YLLAPITAJA	integer	code value

Administrator's ID for the turnaround point	YLLAP_TUNN	text, 20	
Last edited	MUOKKAUSPV	text, 50	time stamp "12.06.2014 13:29:17"
Municipality code	KUNTAKOODI	integer	

Name	Code value	Description
Type of turnaround	1	Circle
	2	Branch shape L
	3	Branch shape I
	9	Not defined
Administrator of the turnaround point	1	Metsäkeskus Forest Centre
	2	Metsähallitus Forestry Service
	3	Tornator
	4	UPM
	5	Metsä Group
	6	Finnsilva
	7	Otso forest services

Speed limit

Line

Description	Field (shape)/ Element (WFS)	Data type (shape)	Additional information
ID	ID	text, 20	
Position	shape/ points	geometry (polylineZ)	ETRS-TM35FIN
Link ID	LINK_ID	text, 20	
Start distance from the start of the link	ALKU_M	double	
End distance from the start of the link	LOPPU_M	double	
Validity direction	VAIK_SUUNT	integer	code value
Value	ARVO	integer	code value, km/h
Last edited	MUOKKAUSPV	text, 50	time stamp "12.06.2014 13:29:17"
Municipality code	KUNTAKOODI	integer	

Name	Code value	Description
------	------------	-------------

Digiroad

Validity direction	1	Both directions
	2	In the direction of digitisation
	3	Against the direction of digitisation
Value	20	20 km/h
	30	30 km/h
	40	40 km/h
	50	50 km/h
	60	60 km/h
	70	70 km/h
	80	80 km/h
	90	90 km/h (Åland)
	100	100 km/h
	120	120 km/h

Maximum total weight

Line

Description	Field (shape)/ Element (WFS)	Data type (shape)	Additional information
ID	ID	text, 20	
Position	shape/ points	geometry (polylineZ)	ETRS-TM35FIN
Link ID	LINK_ID	text, 20	
Start distance from the start of the link	ALKU_M	double	
End distance from the start of the link	LOPPU_M	double	
Validity direction	VAIK_SUUNT	integer	code value
Value	ARVO	integer	kilogramme
Last edited	MUOKKAUSPV	text, 50	time stamp "12.06.2014 13:29:17"
Municipality code	KUNTAKOODI	integer	

Maximum total weight allowed for an articulated vehicle

Line

Description	Field (shape)/ Element (WFS)	Data type (shape)	Additional information
ID	ID	text, 20	
Position	shape/ points	geometry (polylineZ)	ETRS-TM35FIN
Link ID	LINK_ID	text, 20	
Start distance from the start of the link	ALKU_M	double	
End distance from the start of the link	LOPPU_M	double	
Validity direction	VAIK_SUUNT	integer	code value
Value	ARVO	integer	kilogramme
Last edited	MUOKKAUSPV	text, 50	time stamp "12.06.2014 13:29:17"
Municipality code	KUNTAKOODI	integer	

Maximum weight per axle

Line

Description	Field (shape)/ Element (WFS)	Data type (shape)	Additional information
ID	ID	text, 20	
Position	shape/ points	geometry (polylineZ)	ETRS-TM35FIN
Link ID	LINK_ID	text, 20	
Start distance from the start of the link	ALKU_M	double	
End distance from the start of the link	LOPPU_M	double	
Validity direction	VAIK_SUUNT	integer	code value
Value	ARVO	integer	kilogramme
Last edited	MUOKKAUSPV	text, 50	time stamp "12.06.2014 13:29:17"
Municipality code	KUNTAKOODI	integer	

Maximum weight per tandem-axle

Line

Description	Field (shape)/ Element (WFS)	Data type (shape)	Additional information
ID	ID	text, 20	
Position	shape/ points	geometry (polylineZ)	ETRS-TM35FIN
Link ID	LINK_ID	text, 20	
Start distance from the start of the link	ALKU_M	double	
End distance from the start of the link	LOPPU_M	double	
Validity direction	VAIK_SUUNT	integer	code value
Value	ARVO	integer	kilogramme
Last edited	MUOKKAUSPV	text, 50	time stamp "12.06.2014 13:29:17"
Municipality code	KUNTAKOODI	integer	

Maximum height

Line

Description	Field (shape)/ Element (WFS)	Data type (shape)	Additional information
ID	ID	text, 20	
Position	shape/ points	geometry (polylineZ)	ETRS-TM35FIN
Link ID	LINK_ID	text, 20	
Start distance from the start of the link	ALKU_M	double	
End distance from the start of the link	LOPPU_M	double	
Validity direction	VAIK_SUUNT	integer	code value
Value	ARVO	integer	centimetre
Last edited	MUOKKAUSPV	text, 50	time stamp "12.06.2014 13:29:17"
Municipality code	KUNTAKOODI	integer	

Maximum length allowed for a vehicle or articulated vehicle

Line

Description	Field (shape)/ Element (WFS)	Data type (shape)	Additional information
ID	ID	text, 20	
Position	shape/ points	geometry (polylineZ)	ETRS-TM35FIN
Link ID	LINK_ID	text, 20	
Start distance from the start of the link	ALKU_M	double	
End distance from the start of the link	LOPPU_M	double	
Validity direction	VAIK_SUUNT	integer	code value
Value	ARVO	integer	centimetre
Last edited	MUOKKAUSPV	text, 50	time stamp "12.06.2014 13:29:17"
Municipality code	KUNTAKOODI	integer	

Maximum width

Line

Description	Field (shape)/ Element (WFS)	Data type (shape)	Additional information
ID	ID	text, 20	
Position	shape/ points	geometry (polylineZ)	ETRS-TM35FIN
Link ID	LINK_ID	text, 20	
Start distance from the start of the link	ALKU_M	double	
End distance from the start of the link	LOPPU_M	double	
Validity direction	VAIK_SUUNT	integer	code value
Value	ARVO	integer	centimetre
Last edited	MUOKKAUSPV	text, 50	time stamp "12.06.2014 13:29:17"
Municipality code	KUNTAKOODI	integer	

Lit road

Line

Description	Field (shape)/ Element (WFS)	Data type (shape)	Additional information
ID	ID	text, 20	
Position	shape/ points	geometry (polylineZ)	ETRS-TM35FIN
Link ID	LINK_ID	text, 20	
Start distance from the start of the link	ALKU_M	double	
End distance from the start of the link	LOPPU_M	double	
Last edited	MUOKKAUSPV	text, 50	time stamp "12.6.2014 13:29:17"
Municipality code	KUNTAKOODI	integer	

Paved road

Line

Description	Field (shape)/ Element (WFS)	Data type (shape)	Additional information
ID	ID	text, 20	
Position	shape/ points	geometry (polylineZ)	ETRS-TM35FIN
Link ID	LINK_ID	text, 20	
Start distance from the start of the link	ALKU_M	double	
End distance from the start of the link	LOPPU_M	double	
Last edited	MUOKKAUSPV	text, 50	time stamp "12.6.2014 13:29:17"
Municipality code	KUNTAKOODI	integer	

Road affected by thawing

Line

Description	Field (shape)/ Element (WFS)	Data type (shape)	Additional information
ID	ID	text, 20	
Position	shape/ points	geometry (polylineZ)	ETRS-TM35FIN
Link ID	LINK_ID	text, 20	
Start distance from the start of the link	ALKU_M	double	
End distance from the start of the link	LOPPU_M	double	
Last edited	MUOKKAUSPV	text, 50	time stamp "12.06.2014 13:29:17"
Municipality code	KUNTAKOODI	integer	

Width

Line

Description	Field (shape)/ Element (WFS)	Data type (shape)	Additional information
ID	ID	text, 20	
Position	shape/ points	geometry (polylineZ)	ETRS-TM35FIN
Link ID	LINK_ID	text, 20	
Start distance from the start of the link	ALKU_M	double	
End distance from the start of the link	LOPPU_M	double	
Road width	ARVO	integer	centimetre
Last edited	MUOKKAUSPV	text, 50	time stamp "12.6.2014 13:29:17"
Municipality code	KUNTAKOODI	integer	

Traffic volume

Line

Description	Field (shape)/ Element (WFS)	Data type (shape)	Additional information
ID	ID	text, 20	
Position	shape/ points	geometry (polylineZ)	ETRS-TM35FIN
Link ID	LINK_ID	text, 20	
Start distance from the start of the link	ALKU_M	double	
End distance from the start of the link	LOPPU_M	double	
Traffic volume	ARVO	integer	vehicles per day
Last edited	MUOKKAUSPV	text, 50	time stamp "12.6.2014 13:29:17"
Municipality code	KUNTAKOODI	integer	

Vehicle specific restriction

Line

Description	Field (shape)/ Element (WFS)	Data type (shape)	Additional information
ID	ID	text, 20	If one restriction includes several prohibited vehicle types, overlapping objects are included in the shapefile. These objects have the same restriction ID.
Position	shape/ points	geometry (polylineZ)	ETRS-TM35FIN
Link ID	LINK_ID	text, 20	
Start distance from the start of the link	ALKU_M	double	
End distance from the start of the link	LOPPU_M	double	
Validity direction	VAIK_SUUNT	integer	code value
Type of prohibited vehicle	KIELL_AJON	integer	code value
Validity period	VOIM_AIKA	Text, 200	
Exceptions	POIKKEUS	text, 40	comma-separated list of exceptions

Last edited	MUOKKAUSPV	text, 50	time stamp "12.06.2014 13:29:17"
Municipality code	KUNTAKOODI	integer	

Name	Code value	Description
Validity direction	1	Both directions
	2	In the direction of digitisation
	3	Against the direction of digitisation
Vehicle type	2	Motor vehicle
	3	Vehicle
	4	Truck
	5	Bus
	6	Delivery vehicle
	7	Passenger car
	8	Taxi
	9	Motorcycle
	10	Moped
	11	Cycle

Digiroad

	12	Pedestrian
	13	Articulated vehicle
	14	Tractor or farm vehicle
	15	Car with trailer / recreational vehicle
	19	Military vehicle
	21	Driving in service purposes
	22	Driving to a lot
	23	Passage through
	26	Horse riding
	27	Snow mobile

Restriction for the transportation of dangerous goods (VAK)

Line

Description	Field (shape) / Element (WFS)	Data type (shape)	Additional information
ID	ID	text, 20	If one restriction includes both A-VAK and B-VAK, overlapping objects are included in the shapefile. These objects have the same restriction ID.
Position	shape/ points	geometry (polylineZ)	ETRS-TM35FIN
Link ID	LINK_ID	text, 20	
Start distance from the start of the link	ALKU_M	double	
End distance from the start of the link	LOPPU_M	double	
Validity direction	VAIK_SUUNT	integer	code value
Type of prohibited vehicle	KIELL_AJON	integer	code value
Validity period	VOIM_AIKA	Text, 200	
Last edited	MUOKKAUSPV	text, 50	time stamp "12.06.2014 13:29:17"
Municipality code	KUNTAKOODI	integer	

A decorative graphic in the top right corner consisting of several overlapping blue triangles of varying shades, pointing towards the bottom right.

Name	Code value	Description
Validity direction	1	Both directions
	2	In the direction of digitisation
	3	Against the direction of digitisation
Vehicle type	24	A-VAK
	25	B-VAK

Number of lanes*

Line

Description	Field (shape)/ Element(WFS)	Data type (shape)	Additional information
ID	ID	text, 20	
Position	shape/ points	geometry (polylineZ)	ETRS-TM35FIN
Link ID	LINK_ID	text, 20	
Start distance from the start of the link	ALKU_M	double	
End distance from the start of the link	LOPPU_M	double	
Validity direction	VAIK_SUUNT	integer	code value
Number of lanes*	ARVO	integer	number of lanes per carriage way
Last edited	MUOKKAUSPV	text, 50	time stamp "12.06.2014 13:29:17"
Municipality code	KUNTAKOODI	integer	

*) The number of lanes is not yet included in the update and release of Digiroad.

Public transport lane

Line

Description	Field (shape)/ Element (WFS)	Data type (shape)	Additional information
ID	ID	text, 20	
Position	shape/ points	geometry (polylineZ)	ETRS-TM35FIN
Link ID	LINK_ID	text, 20	
Start distance from the start of the link	ALKU_M	double	
End distance from the start of the link	LOPPU_M	double	
Validity direction	VAIK_SUUNT	integer	code value
*)Validity period	VOIM_AIKA	text, 200	time domain
Last edited	MUOKKAUSPV	text, 50	time stamp "12.06.2014 13:29:17"
Municipality code	KUNTAKOODI	integer	

*) The attribute data marked in grey are not yet included in the update and release of Digiroad.

E-road number

Line

Description	Field (shape)/ Element (WFS)	Data type (shape)	Additional information
ID	ID	text, 20	
Position	shape/ points	geometry (polylineZ)	ETRS-TM35FIN
Link ID	LINK_ID	text, 20	
Start distance from the start of the link	ALKU_M	double	
End distance from the start of the link	LOPPU_M	double	
E-road number	EURTIENRO	text, 20	comma-separated list of E-road numbers
Last edited	MUOKKAUSPV	text, 50	time stamp "12.06.2014 13:29:17"
Municipality code	KUNTAKOODI	integer	

Exit number

Line

Description	Field (shape)/ Element (WFS)	Data type (shape)	Additional information
ID	ID	text, 20	
Position	shape/ points	geometry (polylineZ)	ETRS-TM35FIN
Link ID	LINK_ID	text, 20	
Start distance from the start of the link	ALKU_M	double	
End distance from the start of the link	LOPPU_M	double	
Exit number	LIITT_NRO	text, 20	comma-separated list of exit numbers exit number can also include letters
Last edited	MUOKKAUSPV	text, 50	time stamp "12.06.2014 13:29:17"
Municipality code	KUNTAKOODI	integer	

Winter speed limit

Line

Description	Field (shape)/ Element (WFS)	Data type (shape)	Additional information
ID	ID	text, 20	
Position	shape/ points	geometry (polylineZ)	ETRS-TM35FIN
Link ID	LINK_ID	text, 20	
Start distance from the start of the link	ALKU_M	double	
End distance from the start of the link	LOPPU_M	double	
Validity direction	VAIK_SUUNT	integer	code value
Value	ARVO	integer	code value, km/h
Last edited	MUOKKAUSPV	text, 50	time stamp "12.06.2014 13:29:17"
Municipality code	KUNTAKOODI	integer	

A decorative graphic in the top right corner consisting of several overlapping blue triangles of varying shades, pointing towards the bottom right.

Name	Code value	Description
Validity direction	1	Both directions
	2	In the direction of digitisation
	3	Against the direction of digitisation
Value	60	60 km/h
	70	70 km/h
	80	80 km/h
	100	100 km/h

Service Point

Description	Field (shape)/ Element (WFS)	Data type (shape)	Additional information
Service point ID	PALVPISTID	text, 20	If one service point has many services, each of them is presented as an individual data object in service shapefile.
Service ID	PALVELUID	text, 20	
Position	shape/ point	geometry (pointZ)	ETRS-TM35FIN
Type of service	TYYPPI	integer	code value
Specifier of the service type	TYYPPI_TAR	integer	code value
Name of service	NIMI	text, 200	
Additional information of the service	LISATIEDOT	text, 200	
Number of parking spaces	PYSPAIKLKM	integer	
Last edited	MUOKKAUSPV	text, 50	time stamp "12.06.2014 13:29:17"
Municipality code	KUNTAKOODI	integer	

Name	Code value	Description
Type of service	4	Customs
	5	Border crossing
	6	Rest area (or lay-by)
	8	Airport
	9	Ferry terminal
	10	Taxi stand
	11	Railway station
	12	Parking lot
	13	Car shipping terminal
	14	Coach and lorry parking (lot?)
	15	Parking house/building
	16	Bus station
Type of rest area	1	Rest area, comprehensive facilities
	2	Rest area, basic facilities
	3	Private service area
	4	No data

Digiroad

Type of railway station	1	Important railway station
	2	Less important railway station
	3	Underground/metro station



Appendix 2. Public transport stop facility data and other attribute data

Attribute data	Tietotyyppi	Description	Code values
Timetable	Code value	Paper copy of a timetable in a frame attached to the stop wall or post. Provides information on departure times for the routes serving the stop and, where applicable, stop-specific estimated passing times.	1 No 2 Yes 99 No data
Shelter	Code value	A weather shelter located in the stop area for the use of waiting public transport passengers.	1 No 2 Yes 99 No data
Advertising shelter	Code value	A weather shelter displaying advertising, located in the stop area for the use of waiting public transport passengers. In this case, the advertiser will be responsible for the stop maintenance.	1 No 2 Yes 99 No data
Bench	Code value	A bench located in the stop area for the use of waiting public transport passengers. Usually placed under the stop shelter.	1 No 2 Yes 99 No data
Electronic timetable board	Code value	An electronic timetable board found in the stop area and providing real-time information for the routes serving the stop.	1 No 2 Yes

			99 No data
Lighting	Code value	Stop lighting usually refers to the recessed lighting elements in the stop ceiling that provide light inside the shelter.	1 No 2 Yes 99 No data
Accessibility to persons with reduced mobility	Text field	A stop is accessible if it enables independent travelling and waiting by special passenger groups, such as wheelchair users. Stop accessibility is affected by the stop and platform structures, the station and terminal structures and accessibility of the timetable information.	
Possibility to escort by car	Code value	Indicates whether a stop (by a class I road) has a separate passenger drop-off/pick-up area.	1 No 2 Yes 99 No data
Number of park-and-ride places	Character string	Number of park-and-ride parking spaces by a stop.	
Additional information on park-and-ride	Character string	Free text field for additional information on park-and-ride.	
Stop owner	Character string	Stop owner may be other than the data administrator.	

The logo for Digiroad, featuring the word "Digiroad" in white text on an orange rounded rectangular background.

Digiroad

Feedback address	Character string	Address for sending feedback for the stop. For example, an email address.	
Additional information	Text field	Public comments.	

format

Digiroad R is a delivery format for road links and point and line attribute data. In Digiroad, point and line segments are not assigned geometries. However, in the Digiroad R delivery format linear referencing is used to generate the geometries based on the road link, enabling the use of these attributes as independent data. Where necessary, attribute data can be attached to road links by linear referencing. Digiroad R is delivered in ESRI shapefile format.

Digiroad R delivery format includes Digiroad road link data in a DR_LINKKI.shp file. Link IDs have not yet been generated for road links. The unique identifier in use at the moment is the link ID. Digiroad R provides point and line attribute data in separate shapefile files including the attribute data and geometry for each data object, such as DR_NOPEUSRAJOITUS.shp and DR_PYSAKKI.shp. Linear referencing can be carried out on the basis of the road link Link ID and M values provided for the attribute data.

Appendix 4. Description of Digiroad K delivery format

Digiroad K is a delivery format in which road links are disconnected into homogenous parts according to their line attribute data. If a road link includes line segments, it is disconnected according to the line segment start and end points. Line segments are disconnected in the same way as road links. Point attribute data do not disconnect road links or line attribute data.

In Digiroad, point and line segments are not assigned geometries. However, in the Digiroad K delivery format linear referencing is used to generate the geometries based on the disconnected road links. In the Digiroad K delivery format, disconnected line attribute data can be attached to disconnected road links in the road link table by using the SEGM_ID identifier fields. SEGM_ID identifies disconnected road links in the entire data delivery. The identifier is delivery-specific. The Digiroad K delivery format is suitable for purposes such as MapInfo (version 7 or later). Digiroad K is delivered in ESRI shapefile format.

The Digiroad K delivery format provides disconnected Digiroad road link data in a DR_LINKKI_K.shp file. The unique identifier for disconnected road links is the link SEGM_ID. Digiroad K provides point and line attribute data in separate shapefile files including the attribute data and geometry for each data object, such as DR_NOPEUSRAJOITUS_K.shp and DR_PYSAKKI.shp.

Line attribute data can be attached to disconnected road link data by using the road link SEGM_ID provided.

Appendix 5. Primary data sources by data objects

Primary data source refers to a party that provides or offers data for the Digiroad database. Digiroad also receives feedback maintenance data from other administrators and users. Feedback data is passed on to the primary data source for checking.

Data object	Road owner*	Primary data source
Road link: geometry	State Municipality Private	National Land Survey of Finland National Land Survey of Finland National Land Survey of Finland
Road link: Link ID	State Municipality Private	National Land Survey of Finland National Land Survey of Finland National Land Survey of Finland
Road link: administrative class	State Municipality Private	National Land Survey of Finland National Land Survey of Finland National Land Survey of Finland
Road link: functional class	State Municipality Private	Finnish Transport Agency/DR operator Municipality Municipality
Road link: direction of traffic flow**	State Municipality Private	National Land Survey of Finland / DR operator Municipality Municipality
Road link: link type	State Municipality Private	Finnish Transport Agency/DR operator Municipality Municipality
Road link: bridge, underpass or tunnel	State Municipality Private	National Land Survey of Finland / DR operator Municipality Municipality
Road link: Road name and address data	State Municipality Private	National Land Survey of Finland National Land Survey of Finland National Land Survey of Finland
Road link: road address data	State Municipality Private	Finnish Transport Agency Finnish Transport Agency Finnish Transport Agency
Road link: restricted manoeuvre	State Municipality Private	Finnish Transport Agency Municipality Municipality
Public transport stop***	State Municipality Private	Finnish Transport Agency Municipality Municipality
Barrier	State Municipality Private	In Digiroad, not maintained for the time being National Land Survey of Finland /Municipality

		National Land Survey of Finland /Municipality
Traffic light	State Municipality Private	Finnish Transport Agency Municipality Municipality
Pedestrian crossing	State Municipality Private	Finnish Transport Agency Municipality Municipality
Directional traffic sign	State Municipality Private	Finnish Transport Agency - -
Railway crossing****	State Municipality Private	Finnish Transport Agency Finnish Transport Agency Finnish Transport Agency
Forest road turnaround point	Private	Metsähallitus
Speed limit	State Municipality Private	Finnish Transport Agency Municipality Municipality
Maximum allowed x 7	State Municipality Private	Finnish Transport Agency Municipality Municipality
Lit road	State Municipality Private	Finnish Transport Agency Municipality Municipality
Paved road	State Municipality Private	National Land Survey of Finland National Land Survey of Finland National Land Survey of Finland
Road affected by thawing	State Municipality Private	Finnish Transport Agency Municipality Municipality
Width	State Municipality Private	Finnish Transport Agency Municipality Municipality
Traffic volume	State Municipality Private	Finnish Transport Agency Municipality Municipality
Vehicle specific restriction	State Municipality Private	Finnish Transport Agency Municipality Municipality
Carriage of dangerous goods (VAK)	State Municipality Private	Finnish Transport Agency Municipality Municipality

Number of lanes	State Municipality Private	Finnish Transport Agency Municipality Municipality
Public transport lane	State Municipality Private	Finnish Transport Agency Municipality Municipality
E-road number	State Municipality Private	Finnish Transport Agency - -
Exit number	State Municipality Private	Finnish Transport Agency - -
Winter speed limit	State Municipality Private	Finnish Transport Agency Municipality Municipality
Service point	State Municipality Private	Finnish Transport Agency Municipality Municipality

*) Road owner corresponds to the road link attribute 'administrative class'.

**) Direction of traffic flow is provided by the National Land Survey of Finland, but this data can be edited in the Digiroad database, and the National Land Survey of Finland data will not reverse the data edited in Digiroad.

**) Public transport stops are maintained jointly by municipalities and ELY Centres. Some municipalities are also competent transport authorities and responsible for the stop material for several municipalities.

****) The rail track register only provides data on state-owned railway crossings.

Appendix 6. Route type

Route types are not maintained in Digiroad as data objects. However, a route type can be created based on the administrative class and link type, as shown in the table below.

Route type	Code value	Description
Road	1	Road owner is the state (administrative class = 1) and the road is assigned to motor vehicles (road link type 1-7, 10, 11 or 13).
Street	2	Road owner is a municipality (administrative class = 2) and the road is assigned to motor vehicles (road link type 1-7, 10-13).
Privata road	3	Private road owner (administrative class = 3) and the road is assigned to motor vehicles (road link type 1-7, 10-13).
Pedestrian and cycle path	4	The road is assigned to pedestrian and cycle traffic (road link type 8 or 9).
Ferry	6	The road link type is 21 (ferry/cable ferry).

General

Time Domain is defined in GDF and it is a way to indicate precise and complex validity periods for various features and attributes. Notation consists of starting time of the validity period and duration of the validity in the following way: [(starting time){duration}].

For example, [(M5d1){d1}] means:

- Starting time: any year in the fifth month on the 1st day at 00:00:00
- Duration: one day (i.e. 24 hours or 1440 minutes)

Starting time

Notations of Time Domain starting time

Unit of time	Compared time	Code	Values (n,x)	Comment
year		ynnnn	0...9999	
month	of year	Mnn	1...12	
week	of year	wnn	1...53	
day	of month	dnn	1...28/29/30/31	maximum depends on month
day	of week	tn	1...7	from Sunday to Saturday
day of week	week of month	fxn	x: 1...5	week from beginning of month from where validity begins
	day of week		n: 1...7	from Sunday to Saturday
day of week	week of month	lxn	x: 1...5	week from end of month from where validity begins
	day of week		n: 1...7	from Sunday to Saturday
hour	of day	hnn	0...23	
minute	of hour	mnn	0...59	
second	of minute	snn	0...59	

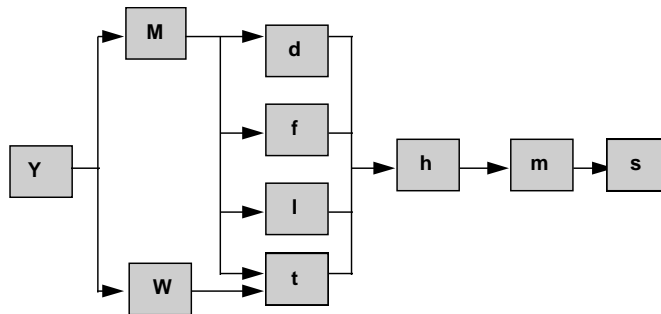

Possible combinations of starting times codes.

Codes are listed from the longest period to the shortest one (y...s). If there is no unit of time marked in the beginning, all values are valid. If there is no unit of time marked in the middle or at the end, the value of the unit is its presumption value, i.e. the smallest possible unit (e.g. M1, w1, d1, h0, m0, s0).

Examples of the notations of starting times:

(y2001) 1.1.2001, 00:00:00

(M5) every year, 1.5. 00:00:00

(w12) every year, Sunday on the 12th week, 00:00:00

(d14) every year, 14th of every month 00:00:00

(t2) every year, Monday of every week 00:00:00

(f23) every year, Tuesday of the second week of every month 00:00:00

(l12) every year, Monday of the last week of every month 00:00:00

(h6) every year, every day of every month 06:00:00

(m30) every year, every day of every month, every hour 30:00

(s15) every year, every day of every month, every hour, every minute :15

(w9h11m30) every year, every day of the 9th week 11:30:00

(M4m30) every year, every day of every April, every hour 30:00

Correspondingly:

14th November 2001 (00:00:00) (y2001M11d14)

every year 2.5. 17:31:00 (M5d2h17m31)

every year, last Sunday of February (M2l11)

Duration

Duration is the total time of Time Domain notations of time units, e.g. {y2M2w1d2}, which means the validity from starting time onwards, for two years + two months + one week + two days.

A minus sign can be added in front of the duration, e.g. {-d5}, which means the validity on the preceding five days.

Notations of Time Domain duration

Unit of time	Code	Values (n)	Correspondence	Comments
year	ynn	0...99		Duration ends on the last day of the month if there is no such day in the year when duration ends, e.g. [(y2000M2d29){y2}).
month	Mnn	1...99	{M12}={y1}	Duration ends on the last day of the month if there is no such day in the month when duration ends, e.g. [(y2001M1d31){M1}).
week	wnn	1...99		
day	dnn	1...99	{d7}={w1}	
hour	hnn	0...99	{h24}={d1}	
minute	mnn	0...99	{m60}={h1}	
second	snn	0...99	{s60}={m1}	

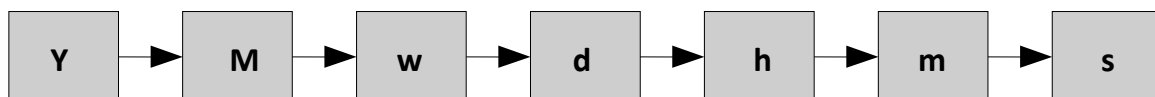

Possible combinations of duration.

Time Domain combinations

There are combination options defined in the Time Domain notations that make it possible to indicate more complex durations. The following options are in use:

- A+B: property is valid in both cases (OR)
- A*B: property is valid when both are valid (AND)
- A-B: property is valid when only A is valid (A AND NOT B)

With combinations the same result can be achieved in several different ways, because e.g. $A*(B+C) = (A*B)+(A*C)$.

- Every day from 9 a.m. to 1 p.m.
[[h9]{h4}]
- Every Friday in March from 7.30 p.m. to 10 p.m.
[(M3t6h19m30){h2m30}]
- The last 15 minutes of the year 2001 (15 minutes before the year 2002)
[(y2002){-m15}]
- Every day from Monday to Saturday between 9 a.m. and 12 noon and between 1.30 and 7 p.m., except on the last Tuesday in January, 1st of May and in August
[[[[[h9]{h3}]+[h13m30]{h5m30}]]*[(t2){d6}]]-[(M1t13){d1}]-[(M5){d1}]-[(M8){M1}]]